

## Malbild

Verleih dem Bild ein bisschen Farbe.



## Fehlerbild

Jasmin hatte einen Fahrradunfall, zum Glück ist Jonas da, der ihr hilft!  
Finde die 10 Unterschiede im unteren Bild.

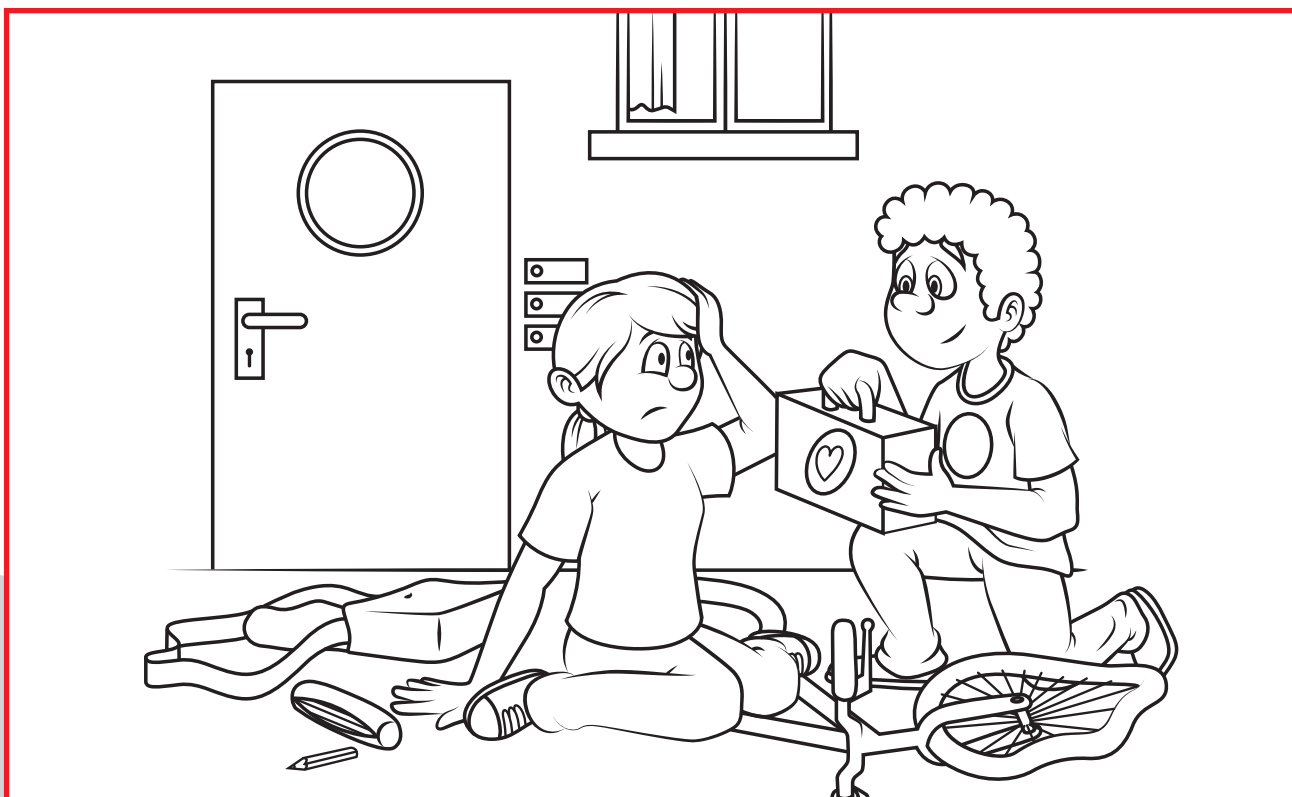
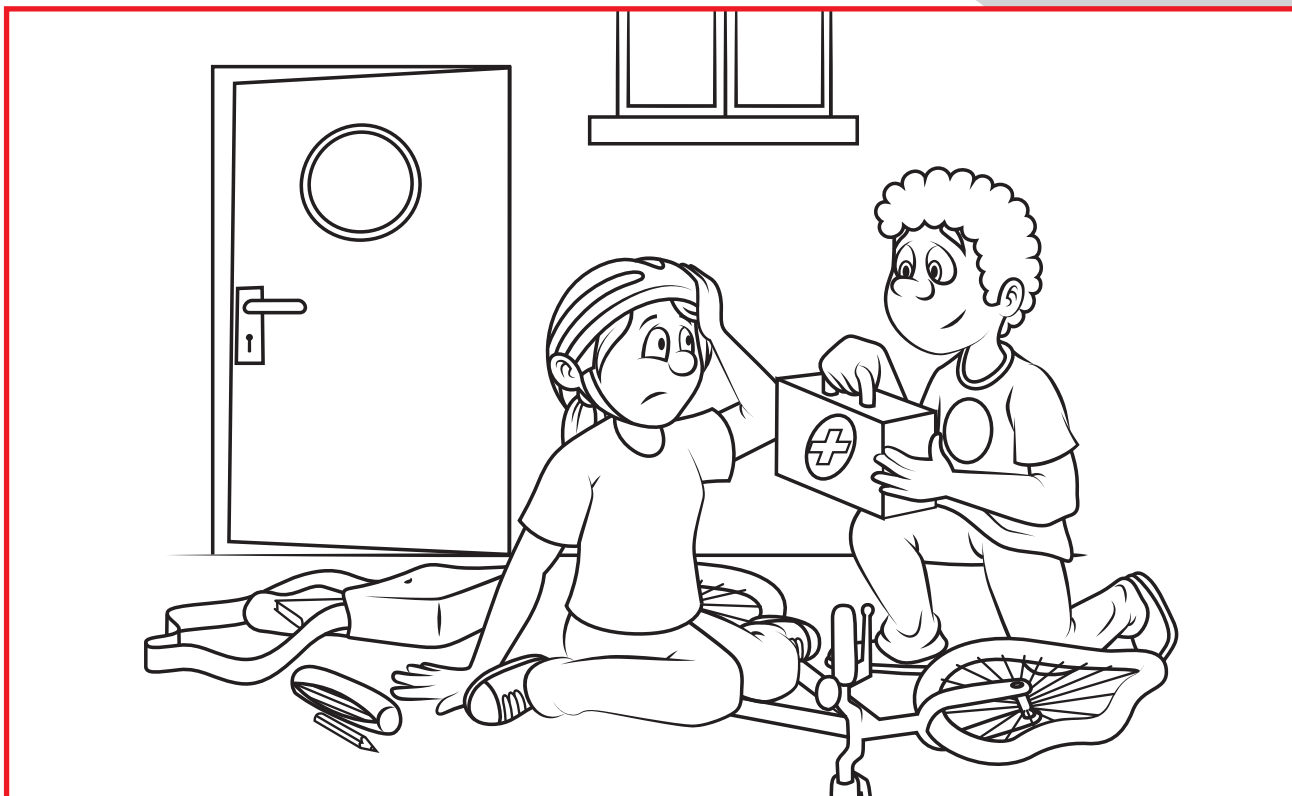

# Wörter finden

Ein ganz schönes Durcheinander. Findest du die gesuchten Wörter?

## Suche folgende Wörter:

- Erste Hilfe
- Helfen
- Help
- Defibrillator
- Pflaster

- Samariter
- Sanität
- Unfall
- Verband
- Held



# Labyrinth

Aua! Lukas hat sich in den Finger geschnitten.  
Finde das Pflaster und hilf ihm.

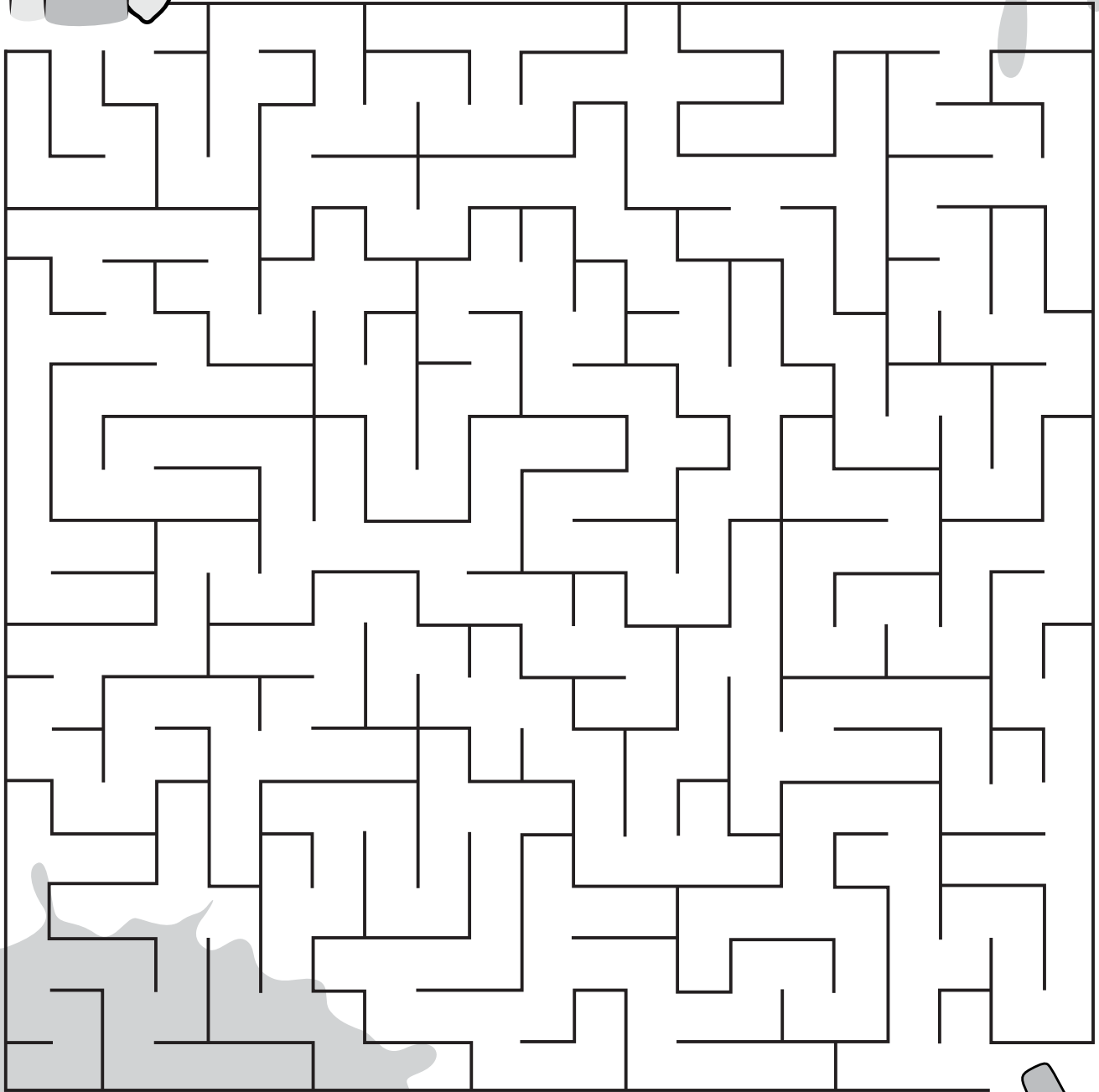
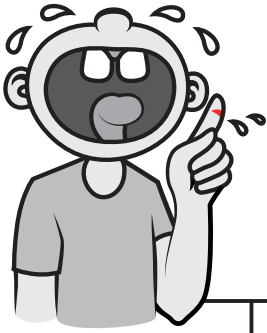

## Was gehört wozu?

Kennst du die Notfallnummern? Bei welcher Telefonnummer kommt dir wer zu Hilfe?  
Verbinde die Nummern mit dem Fahr-/Flugzeug.

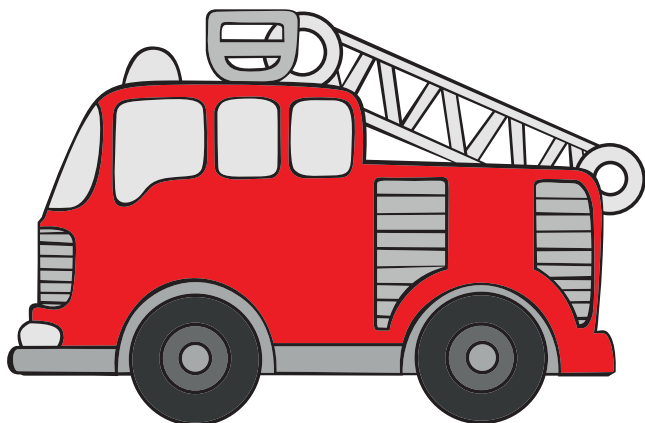

117



118



1414



144

# Malen nach Zahlen

Mal die Felder in der entsprechenden Farbe aus. Was siehst du?

1 Schwarz    2 Braun    3 Hellbraun    4 Grau    5 Gelb    6 Rot



# Geschichte erzählen

Bringe die Geschichte in die richtige Reihenfolge und du weisst, was uns am Leben hält.

Lösungswort: -----

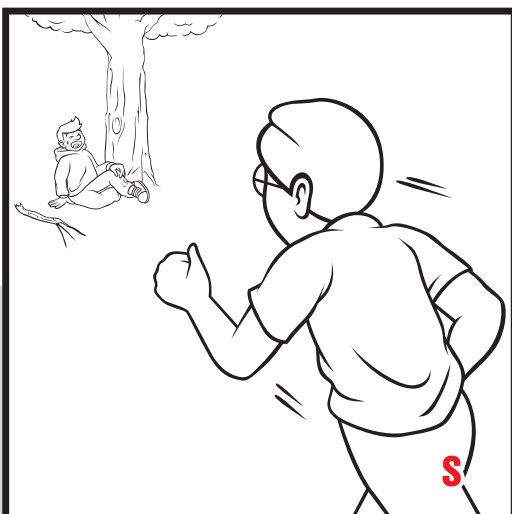
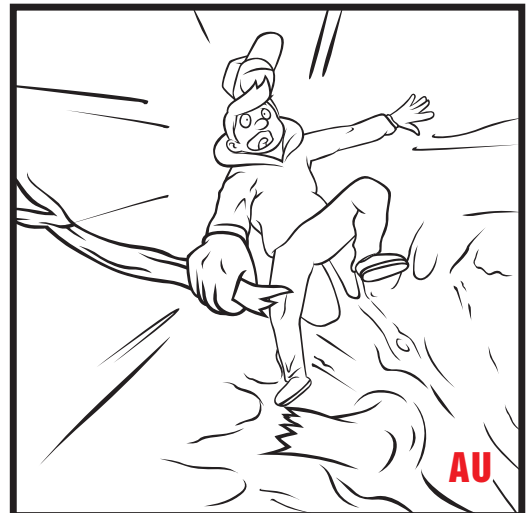
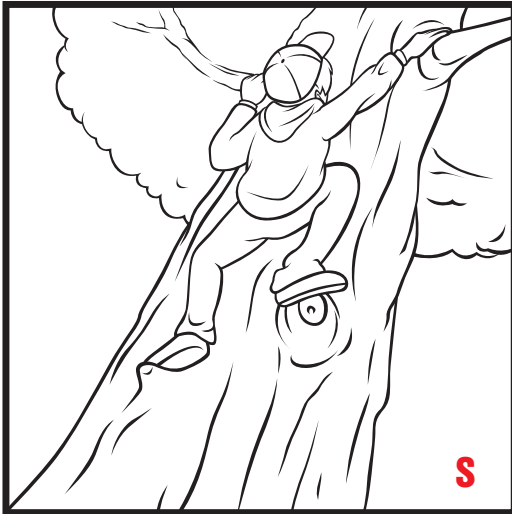

# Zahlenbild

Tatütata... Verbinde die Punkte.

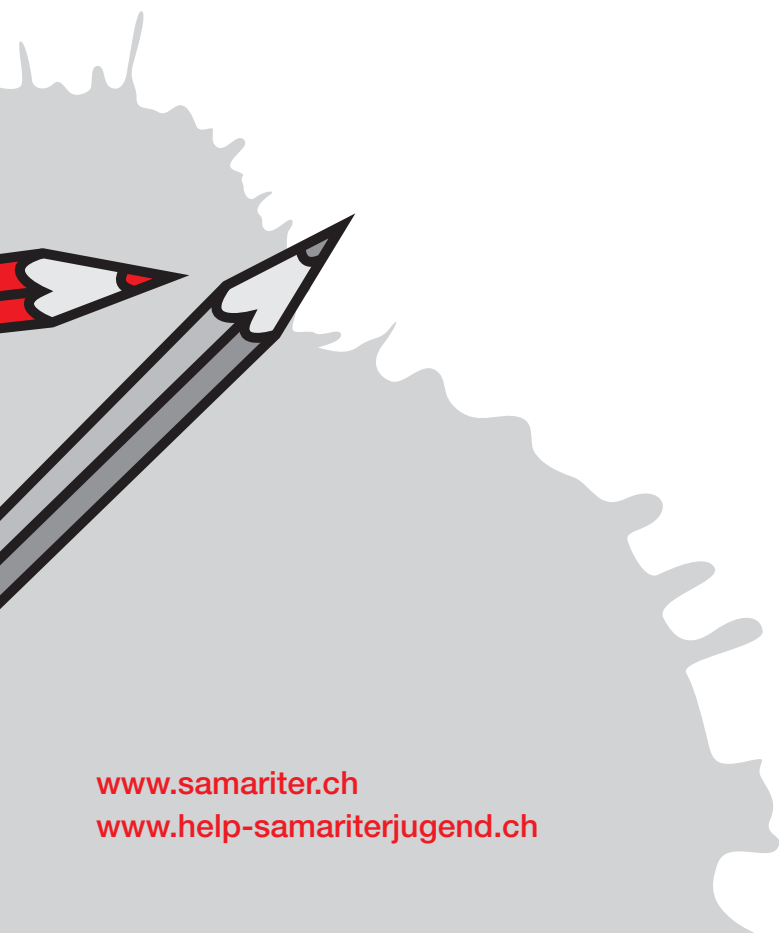
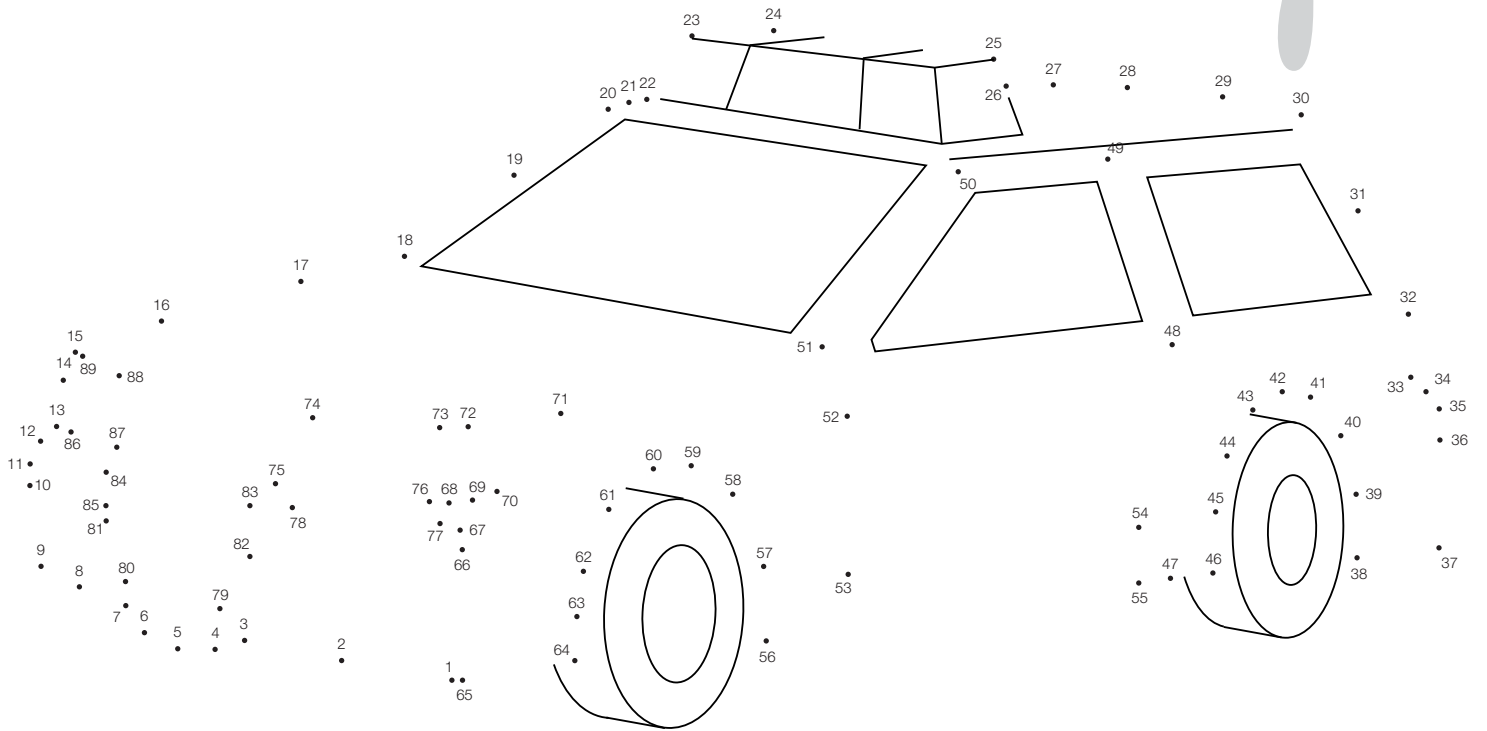



## Wimmelbild

Auf diesem Bild hat sich einiges versteckt.

Finde: 12 Pflaster, 2 Cervelats, 3 Verbände, 1 Spritze, 2 Sonnenbrillen, 2 Help-Logos.



# Kreuzworträtsel

Setze die Namen der Dinge an der richtigen Stelle im Rätsel ein und du weisst, wovor du keine Angst zu haben brauchst.



1



6

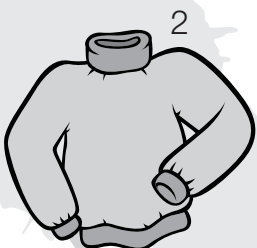
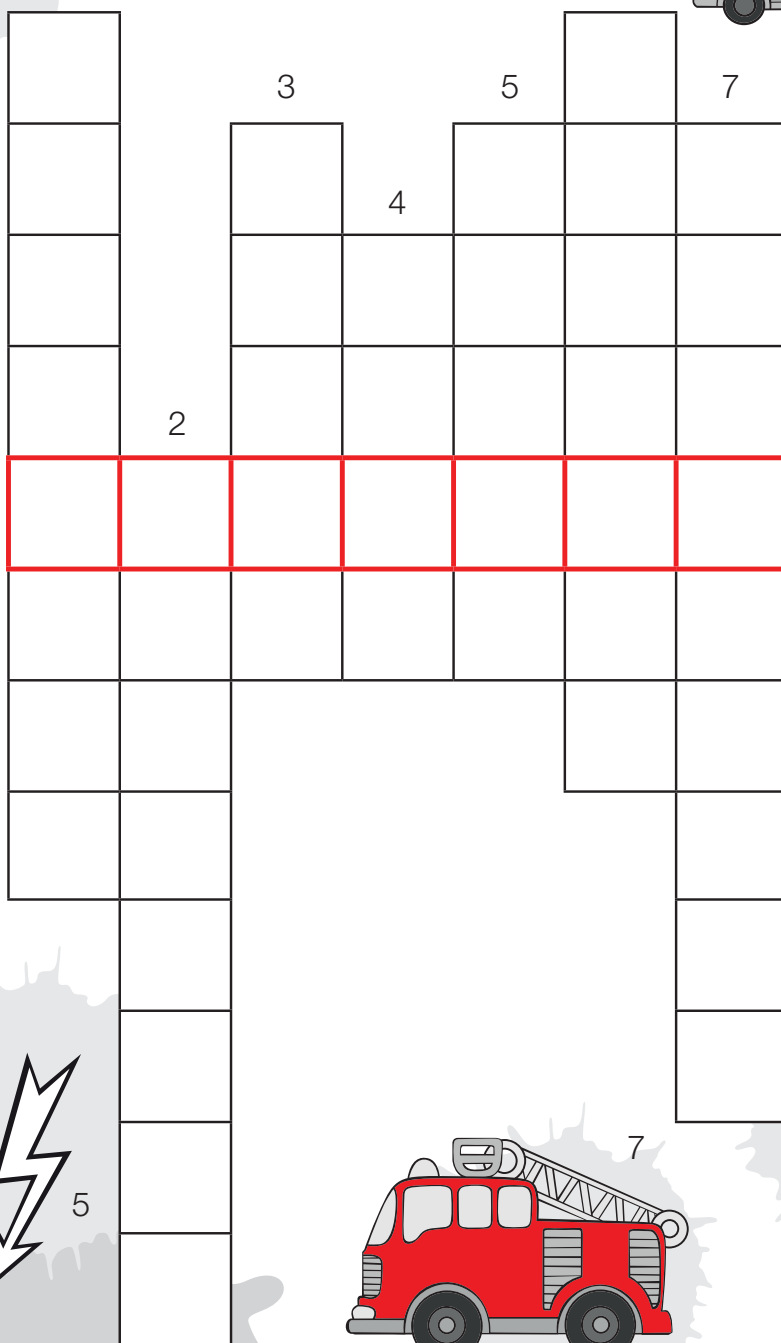

2



5



4



7



3

# Schattenspiel

Welcher Schatten stammt von unserer Mumie?

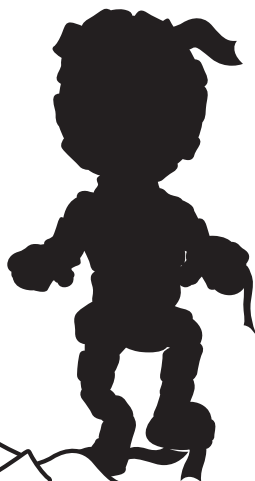

# Lösungen

## Fehlerbild

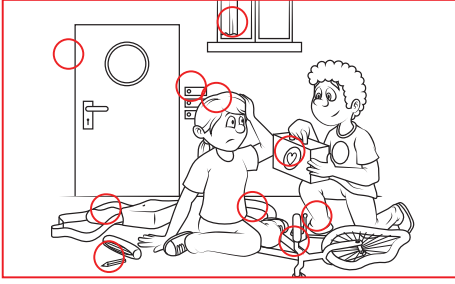

## Wörter finden

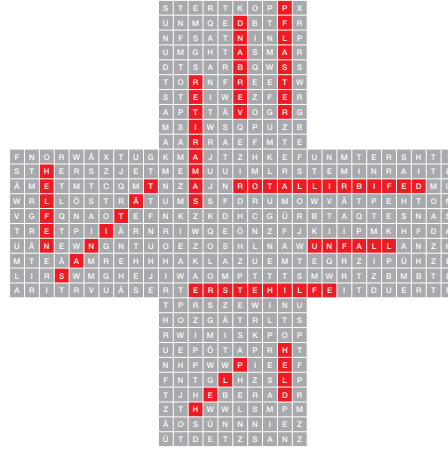

## Labyrinth

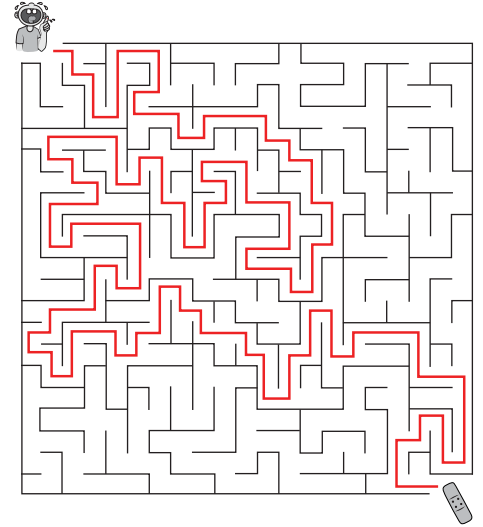

## Was gehört wozu?

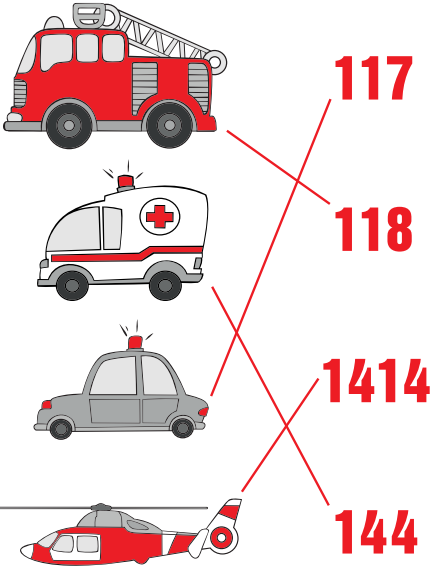

## Geschichte erzählen

**Lösungswort:**  
SAUERSTOFF

## Wimmelbild

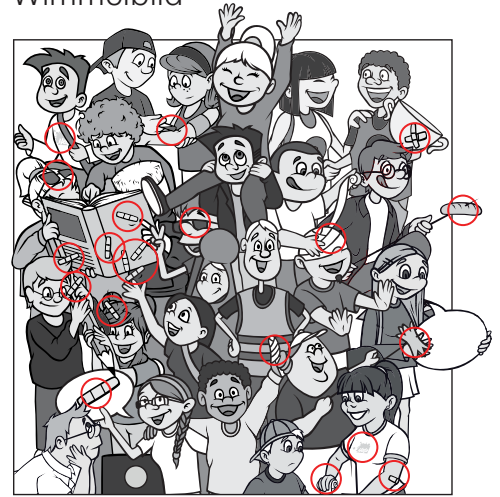

## Kreuzworträtsel

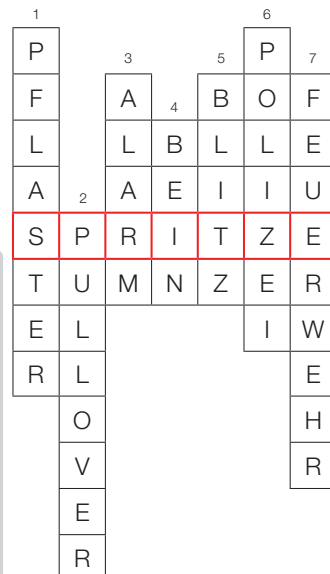

## Schattenspiel

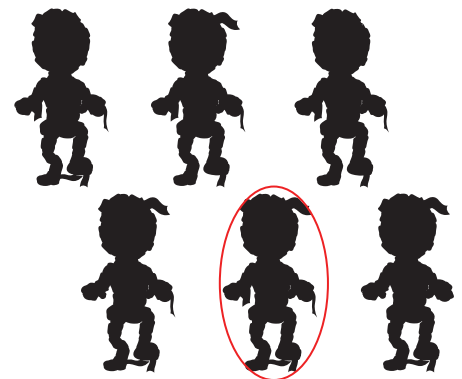

# Lösungen

## Fehlerbild

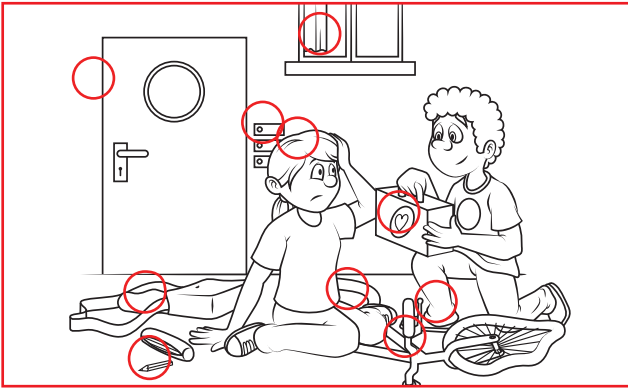

## Wimmelbild

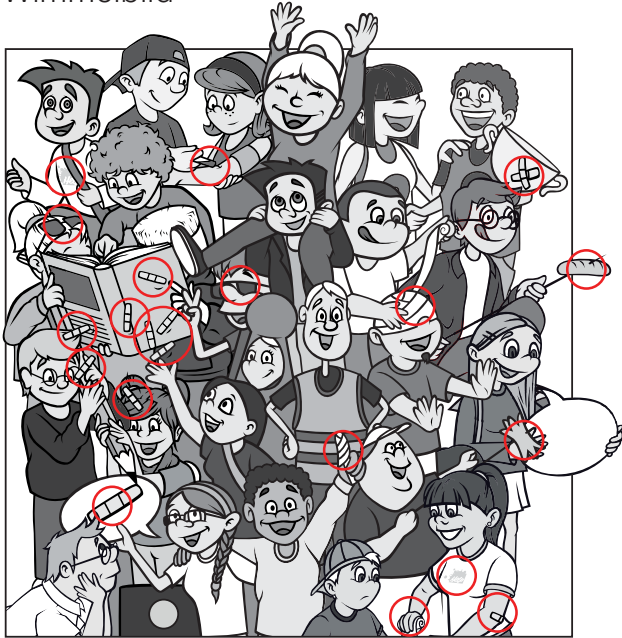

## Schattenspiel



[www.samariter.ch](http://www.samariter.ch)  
[www.help-samariterjugend.ch](http://www.help-samariterjugend.ch)

## Was gehört wozu?

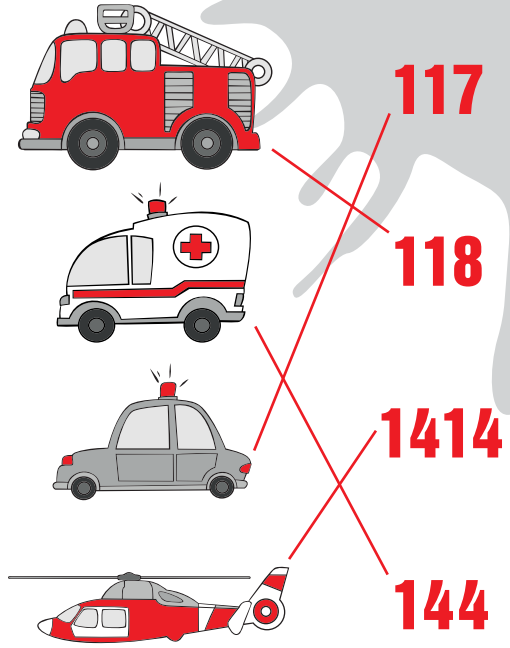

## Labyrinth

